

Service Manual

AV Control Stereo Receiver

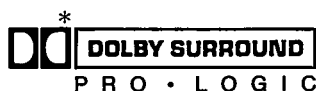

Receiver

SA-GX390

Colour

(K) ... Black Type

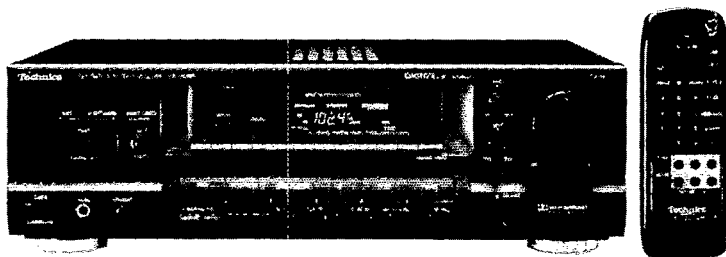

Areas

Suffix for Model No.	Area	Colour
(E)	Europe.	(K)
(EB)	Great Britain.	
(EG)	Germany and Italy.	
(G)	Asia, Latin America, Middle Near East and Africa.	
(GN)	Oceania.	

SPECIFICATIONS (DIN 45 500)

■ AMPLIFIER SECTION

Power output (at 240 V)	
DIN 1 kHz (T.H.D. 1%)	
[For (E, EB, EG) areas.]	2 × 50 W (4 Ω)
[For (G, GN) areas.]	2 × 60 W (8 Ω)
40 Hz–20 kHz continuous power output both channels driven	
[For (E, EB, EG) areas.]	2 × 30 W (8 Ω)
[For (G, GN) areas.]	2 × 40 W (8 Ω)
Total harmonic distortion	
rated power at 40 Hz–20 kHz	0.5% (8 Ω)
half power at 1 kHz	0.03% (8 Ω)
Power output at the Dolby Pro Logic operation	
DIN 1 kHz (T.H.D. 1%)	
Front [For (E, EB, EG) areas.]	2 × 40 W (4 Ω)
[For (G, GN) areas.]	2 × 40 W (8 Ω)
Center	40 W (8 Ω)
Surround	40 W (8 Ω)
Intermodulation distortion	
rated power at 60 Hz: 7 kHz=4:1, SMPTE	0.5% (8 Ω)
Power bandwidth	
both channels driven, –3 dB	10 Hz–40 kHz (8 Ω)
Damping factor	30 (8 Ω)
Input sensitivity and impedance	
PHONO	3 mV/47 kΩ
CD, VCR 1, VCR 2/VIDEO CD, TAPE	200 mV/22 kΩ
S/N at rated power (8 Ω)	
PHONO	70 dB (IHF, A: 80 dB)
CD, VCR 1, VCR 2/VIDEO CD, TAPE	75 dB (IHF, A: 88 dB)
Frequency response	
PHONO	RIAA standard curve
	(30 Hz–15 kHz) ± 0.8 dB
CD, VCR 1, VCR 2/VIDEO CD, TAPE	10 Hz–40 kHz, ± 3 dB
Tone controls	
BASS	50 Hz, +10 to –10 dB
TREBLE	20 kHz, +10 to –10 dB
Output voltage	
VCR 1 OUT, TAPE REC (OUT)	200 mV

* Manufactured under license from Dolby Laboratories Licensing Corporation. Additionally licensed under one or more of the following patents: U.S. numbers 3,632,886, 3,746,792 and 3,959,590; Canadian numbers 1,004,603 and 1,037,877. "Dolby" and the double-D symbol are trademarks of Dolby Laboratories Licensing Corporation.

Channel balance (250 Hz–6.3 kHz)	± 1 dB
Channel separation	55 dB
Headphones output level and impedance	430 mV/330 Ω
Load impedance	
Front [For (E, EB, EG) areas.]	4–16 Ω
[For (G, GN) areas.]	8–16 Ω
Center	8–16 Ω
Surround	4–16 Ω

■ FM TUNER SECTION

Frequency range	87.50–108.00 MHz
Sensitivity	
S/N 30 dB	1.5 μV/75 Ω
S/N 26 dB	1.3 μV/75 Ω
S/N 20 dB	1.2 μV/75 Ω
IHF usable sensitivity	(IHF '58) 1.5 μV/75 Ω
IHF 46 dB stereo quieting sensitivity	22 μV/75 Ω
Total harmonic distortion	
MONO	0.2%
STEREO	0.3%
S/N	
MONO	60 dB (75 dB, IHF)
STEREO	58 dB (71 dB, IHF)
Frequency response	20 Hz–15 kHz, +1 dB, –2 dB
Alternate channel selectivity	
± 400 kHz	65 dB
Capture ratio	1 dB
Image rejection at 98 MHz	40 dB
IF rejection at 98 MHz	70 dB
Spurious response rejection at 98 MHz	70 dB
AM suppression	50 dB
Stereo separation	
1 kHz	40 dB

Technics®

© 1995 Matsushita Electric Industrial Co., Ltd.
All rights reserved. Unauthorized copying and distribution is a violation of law.

⚠ WARNING

This service information is designed for experienced repair technicians only and is not designed for use by the general public. It does not contain warnings or cautions to advise non-technical individuals of potential dangers in attempting to service a product. Products powered by electricity should be serviced or repaired only by experienced professional technicians. Any attempt to service or repair the product or products dealt with in this service information by anyone else could result in serious injury or death.

Carrier leak	
19 kHz	-30 dB (-35 dB, IHF)
38 kHz	-50 dB (-55 dB, IHF)
Channel balance (250 Hz-6.3 kHz)	±1.5 dB
Limiting point	1.2 μV
Bandwidth	
IF amplifier	180 kHz
FM demodulator	1000 kHz
Antenna terminal(s)	75 Ω (unbalanced)

■ AM TUNER SECTION

• For (E, EB) areas.

Frequency range	
MW	522-1611 kHz (9 kHz steps) 530-1620 kHz (10 kHz steps) 144-288 kHz
LW	
Sensitivity	
MW	20 μV, 330 μV/m
LW	45 μV
Selectivity	
MW (at 999 kHz)	55 dB
LW (at 252 kHz)	55 dB
Image rejection	
MW (at 999 kHz)	40 dB
LW (at 252 kHz)	40 dB
IF rejection	
MW (at 999 kHz)	55 dB
LW (at 252 kHz)	55 dB

• For (EG, G, GN) areas.

Frequency range	522-1611 kHz (9 kHz steps) 530-1620 kHz (10 kHz steps)
Selectivity	20 μV, 330 μV/m

Selectivity at 999 kHz	55 dB
Image rejection at 999 kHz	40 dB
IF rejection at 999 kHz	55 dB

■ VIDEO SECTION

Output voltage at 1 V Input (unbalanced)	1 ± 0.1 Vp-p
Maximum input voltage	1.5 Vp-p
Input/output impedance	75 Ω (unbalanced)

■ GENERAL

Power consumption	
[For (E, EB, EG) areas.]	220 W
[For (G, GN) areas.]	190 W
Power supply	
[For (E, EB, EG, GN) areas.]	AC 50/60 Hz, 230-240 V
[For (G) area.]	AC 50/60 Hz, 110-127 V/220-240 V
Dimensions (W × H × D)	430 × 136 × 352 mm
Weight	7.8 kg

■ REMOTE CONTROL TRANSMITTER

Control keys	38 keys
Dimensions (W × H × D)	62 × 24.5 × 176 mm
Weight (including batteries)	106 g (3.2 oz)
Power source	Two UM-4/AAA (Panasonic R03/LR03 or equivalent)

Notes:

- Design and specifications are subject to change without notice. Weight and dimensions are approximate.
- Total harmonic distortions is measured by the digital spectrum analyzer.

■ CONTENTS

ACCESSORIES	Page
CAUTIONS FOR AC MAINS LEAD	2
PROTECTION CIRCUITRY	3
FRONT PANEL CONTROLS	4
BEFORE REPAIR AND ADJUSTMENT	4
EQUIPMENT CONNECTIONS	5, 6
REMOTE CONTROL OPERATION	7, 8
OPERATION CHECKS AND MAIN COMPONENT REPLACEMENT PROCEDURE	9~14
FAN MOTOR TROUBLESHOOTING	15
TROUBLESHOOTING	16~19

OVERLOAD DETECTION FUNCTION	Page
BLOCK DIAGRAM	20~24
TERMINAL GUIDE	25
TERMINAL GUIDE OF IC'S TRANSISTORS AND DIODES	26
SCHEMATIC DIAGRAM	27~40
PRINTED CIRCUIT BOARDS	41~46
WIRING CONNECTION DIAGRAM	47
CABINET PARTS LOCATION	48, 49
REPLACEMENT PARTS LIST	50~52, 56
RESISTORS AND CAPACITORS	53~55
PACKAGING	56

■ ACCESSORIES

AC power supply cord 1 pc.
[RJA0019-2K] [VJA0733 (EB)]
(E, EG, G)]

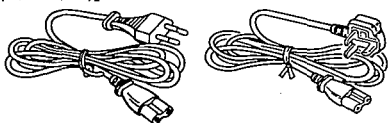

[RJA0036-K (GN)]

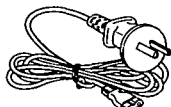

FM indoor antenna 1 pc.
(RSA0007)



Attachment plug 1 pc.
[SJP9009 (EB)]



AM loop antenna set 1 pc.
(RSA0010)
• AM antenna holder 1 pc.
(RMN0244)
• Screw 1 pc.
(XTN3+12AFZ)

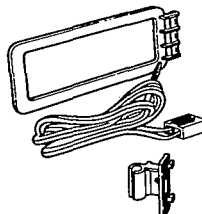

Power plug adaptor 1 pc.
[SJP5213-2 (G)]



Remote control transmitter 1 pc.
(RAK-SA179XH)



Batteries for remote control transmitter 2 pcs.
("AAA", R03)



Note: These are available on sale route.

Antenna plug 1 pc.
[RFE0014 (G, GN)]

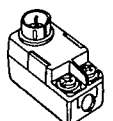

CAUTIONS FOR AC MAINS LEAD



("EB" area code model only)

For your safety, please read the following text carefully.

This appliance is supplied with a moulded three pin mains plug for your safety and convenience.

A 5-ampere fuse is fitted in this plug.

Should the fuse need to be replaced please ensure that the replacement fuse has a rating of 5-ampere and that it is approved by ASTA or BSI to BS1362.

Check for the ASTA mark  or the BSI mark  on the body of the fuse.

If the plug contains a removable fuse cover you must ensure that it is refitted when the fuse is replaced.

If you lose the fuse cover the plug must not be used until a replacement cover is obtained.

A replacement fuse cover can be purchased from your local dealer.

CAUTION!

IF THE FITTED MOULDED PLUG IS UNSUITABLE FOR THE SOCKET OUTLET IN YOUR HOME THEN THE FUSE SHOULD BE REMOVED AND THE PLUG CUT OFF AND DISPOSED OF SAFELY.

THERE IS A DANGER OF SEVERE ELECTRICAL SHOCK IF THE CUT OFF PLUG IS INSERTED INTO ANY 13-AMPERE SOCKET.

If a new plug is to be fitted please observe the wiring code as shown below.

If in any doubt please consult a qualified electrician.

IMPORTANT

The wires in this mains lead are coloured in accordance with the following code:

Blue: Neutral, Brown: Live.

As these colours may not correspond with the coloured markings identifying the terminals in your plug, proceed as follows:
The wire which is coloured Blue must be connected to the terminal which is marked with the letter N or coloured Black or Blue.

The wire which is coloured Brown must be connected to the terminal which is marked with the letter L or coloured Brown or Red.

WARNING: DO NOT CONNECT EITHER WIRE TO THE EARTH TERMINAL WHICH IS MARKED WITH THE LETTER E, BY THE EARTH SYMBOL \perp OR COLOURED GREEN OR GREEN/YELLOW.

THIS PLUG IS NOT WATERPROOF—KEEP DRY.

Before use

Remove the connector cover as follows.

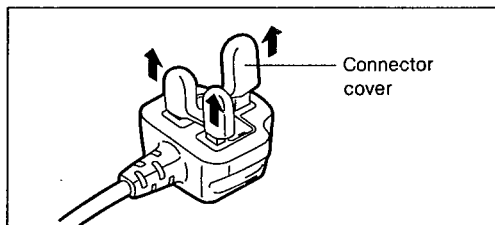

How to replace the fuse

1. Remove the fuse cover with a screwdriver.

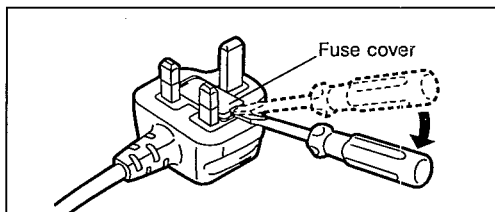

2. Replace the fuse and attach the fuse cover

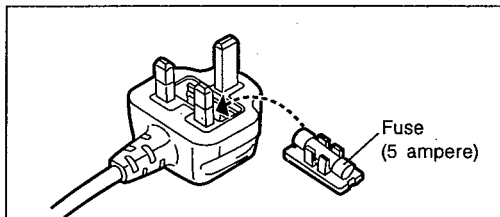

PROTECTION CIRCUITRY

The protection circuitry may have operated if either of the following conditions is noticed:

- No sound is heard when the power is turned on.
- Sound stops during a performance.

The function of this circuitry is to prevent circuitry damage if, for example, the positive and negative speaker connection wires are "shorted", or if speaker systems with an impedance less than the indicated rated impedance of the amplifier are used.

If this occurs, follow the procedure outlines below:

1. Turn off the power.
2. Determine the cause of the problem and correct it.
3. Turn on the power once again after one minute.

Note:

When the protection circuitry functions, the unit will not operate unless the power is first turned off and then on again.

FRONT PANEL CONTROLS

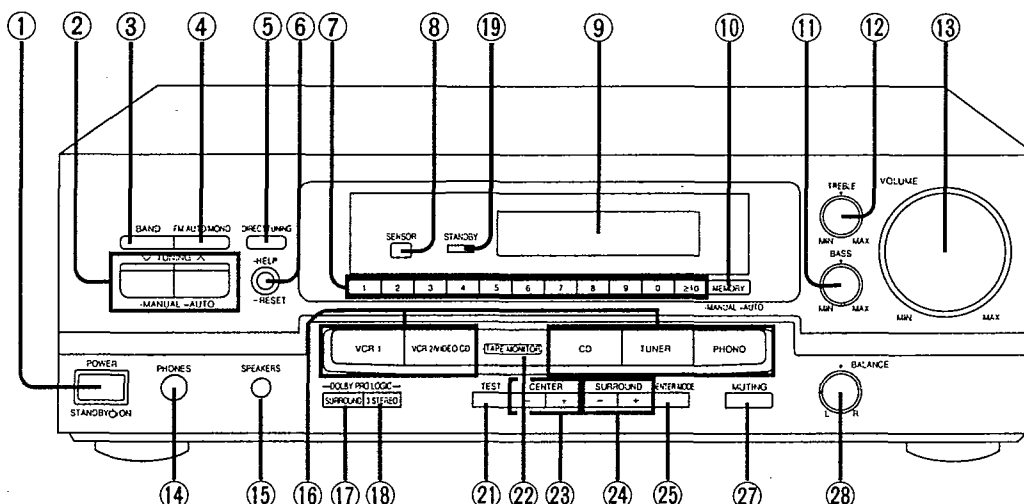

No.	Name
①	Power switch (POWER)
②	Tuning control (TUNING)
③	Band select button (BAND)
④	FM mode select button (FM AUTO/MONO)
⑤	Direct tuning button (DIRECT TUNING)
⑥	Help/reset button (-HELP - RESET)
⑦	Numeric buttons (1-0, ≥10)
⑧	Remote control signal receptor
⑨	Display
⑩	Memory button (MEMORY)
⑪	Bass control (BASS)
⑫	Treble control (TREBLE)
⑬	Volume control (VOLUME)
⑭	Headphone jack (PHONES)
⑮	Speaker ON/OFF button (SPEAKERS)
⑯	Input select buttons

No.	Name
⑰	Surround ON/OFF button (SURROUND)
⑱	3 stereo ON/OFF button (3 STEREO) DOLBY PRO LOGIC mode select button (PRO LOGIC)
⑲	"STANDBY" indicator When the unit is connected to the AC mains supply, this indicator lights up in standby mode and goes out when the unit is turned on.
㉑	Test signal ON/OFF button (TEST)
㉒	Tape monitor button (TAPE MONITOR)
㉓	Center level adjust button (CENTER)
㉔	Surround level adjust button (SURROUND)
㉕	Center mode select button (CENTER MODE)
㉗	Muting button (MUTING)
㉘	Balance control (BALANCE)

BEFORE REPAIR AND ADJUSTMENT

Disconnect AC power, Discharge both Power Supply Capacitors C703 and C704 (56V 6800 μ F) through a 10 Ω , 5W resistor to ground.

DO NOT SHORT-CIRCUIT DIRECTLY (with a screwdriver blade, for instance), as this may destroy solid state devices. After repairs are completed, restore power gradually using a variac, to avoid overcurrent.

Current consumption at 50Hz/60Hz in NO SIGNAL mode should be shown below with respect to supply voltage AC 230V/240V.

Power supply voltage	AC 230V		AC 240V		AC 110-127V		AC 220-240V	
Consumed current 50/60Hz	50Hz	140~420mA	50Hz	150~450mA	50Hz	300~800mA	50Hz	150~450mA
	60Hz	112~336mA	60Hz	120~360mA	60Hz	240~640mA	60Hz	120~360mA

EQUIPMENT CONNECTIONS

Connecting audio equipment

Stereo connection cable (not included)

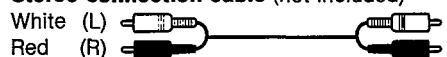

Note

Do not place books, etc., on top of this unit or block the heat radiation vents in any way.

CD changer (or CD player) (not included)

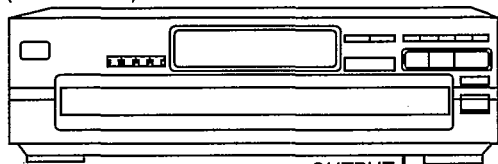

Tape deck (not included)

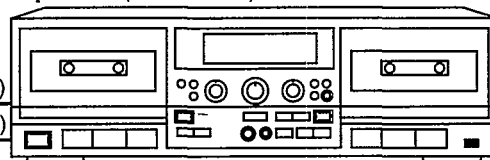

Only for turntable
with ground terminal

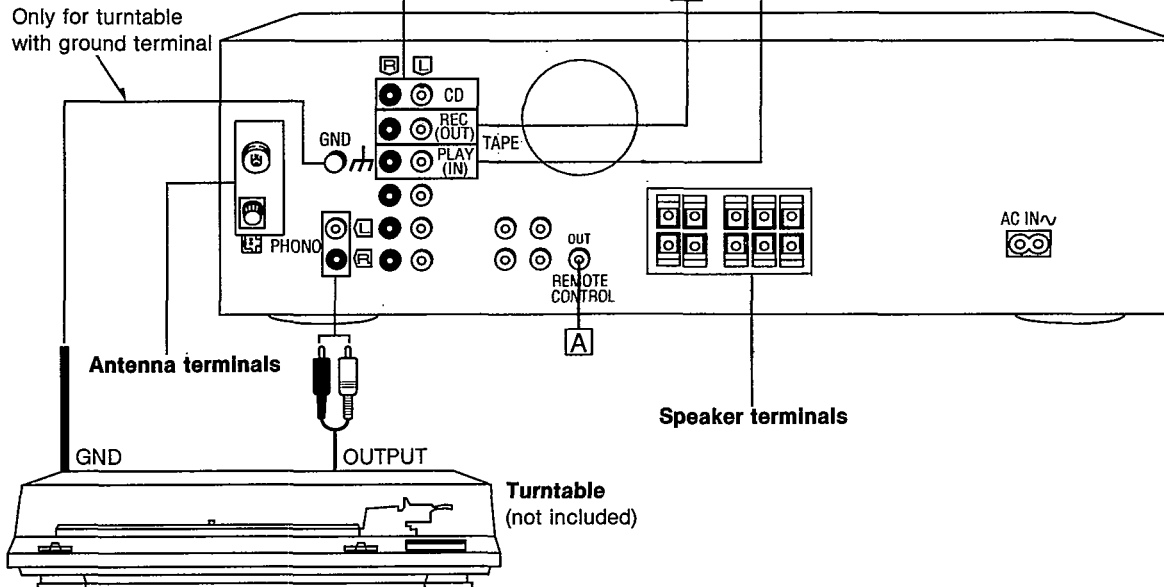

A "REMOTE CONTROL OUT" terminal

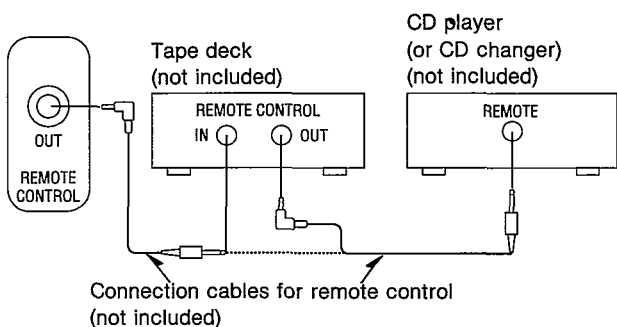

Connect the connection cable for remote control to a Technics tape deck and/or CD changer (or CD player) which has the appropriate remote control terminal as shown above.

If a tape deck is not being used, the CD changer (or CD player) can be connected directly (dotted line).

Note

For a tape deck and/or CD changer (or CD player) with a remote control sensor, this connection is not necessary.

To set the power voltage

[For (G) area only.]

Set the voltage adjustment to the voltage setting for the area in which the unit will be used.

Note

Note that this unit will be seriously damaged if this setting is not made correctly.

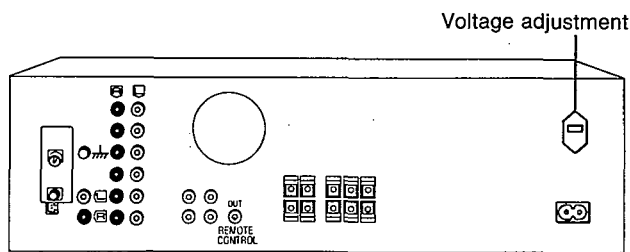

Connecting video equipment

Stereo connection cable (not included)

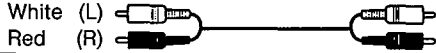

Second VCR (for playback only) or video CD changer (not included)

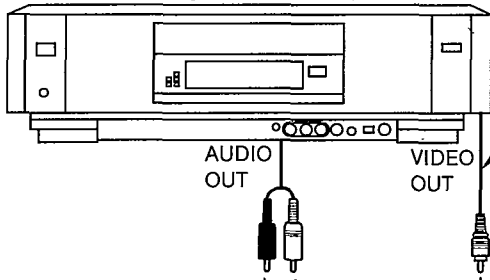

TV (not included)

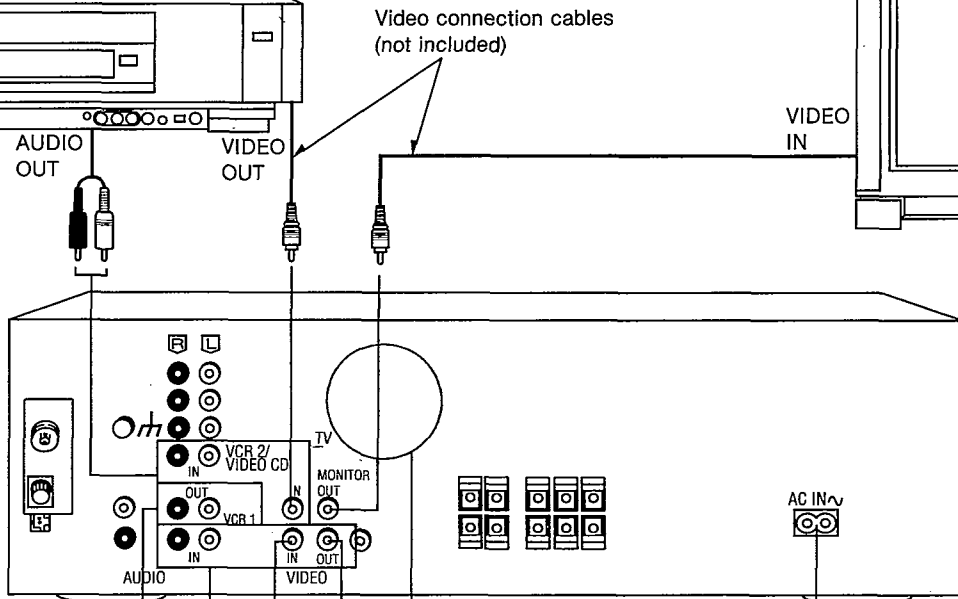
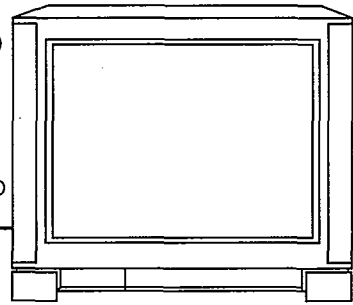

Video connection cables (not included)

Cooling fan

The cooling fan operates at high power output levels only.

Video connection cables (not included)

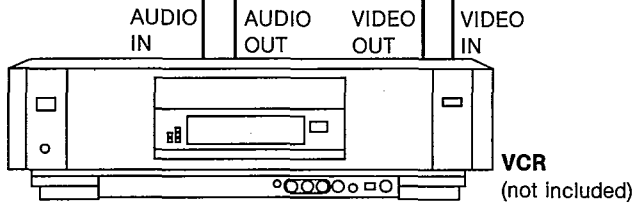

[For (EB) area only.]

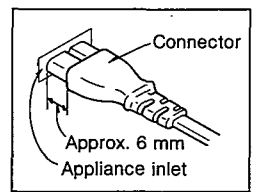

Even when the connector is perfectly inserted, the front part of the connector jut out as shown in the drawing. However there is no problem using the unit.

AC power supply cord (included)

Connect this cord after all other cables and cords are connected.

To connect a video deck with 21 pin scart terminal

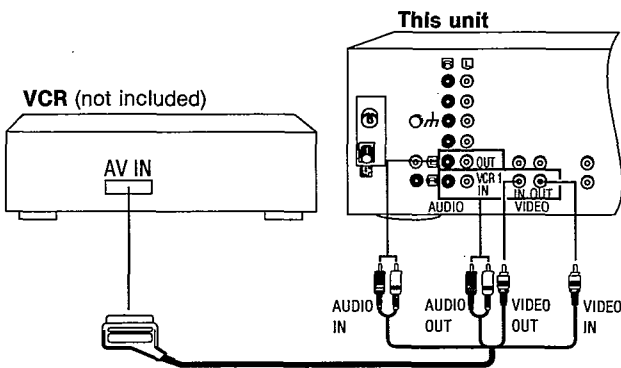

21 pin scart cable (not included)

[For (EB) area only.]

BE SURE TO READ THE CAUTION FOR THE AC POWER SUPPLY CORD ON PAGE 2 BEFORE CONNECTION.

[For (G) area only.]

If the power plug will not fit your socket, use the power plug adaptor (included).

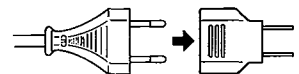









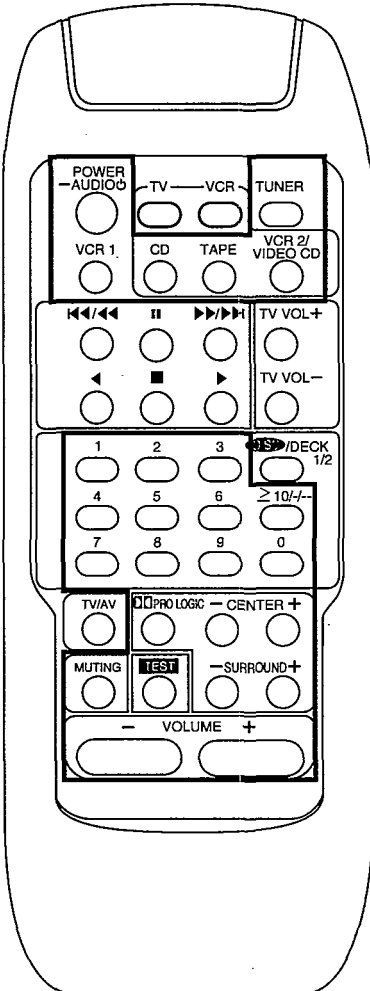



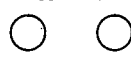
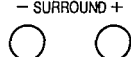

REMOTE CONTROL OPERATION

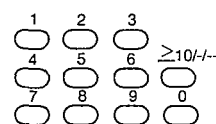
This remote control transmitter can be used to operate other units manufactured by this company in addition to this receiver, including TVs and VCRs manufactured since 1985, CD players (or CD changers), tape decks and video CD changers.

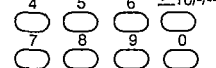
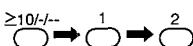

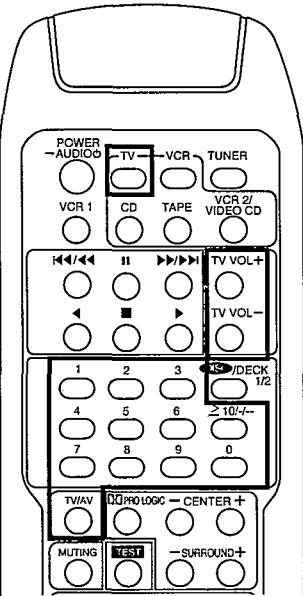

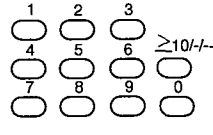

- For detailed information concerning operation steps, etc., please refer to the appropriate page for each unit and the respective operating instructions.
- Make sure that the power of each unit is set to the "ON" position before beginning the operations.

To operate the receiver

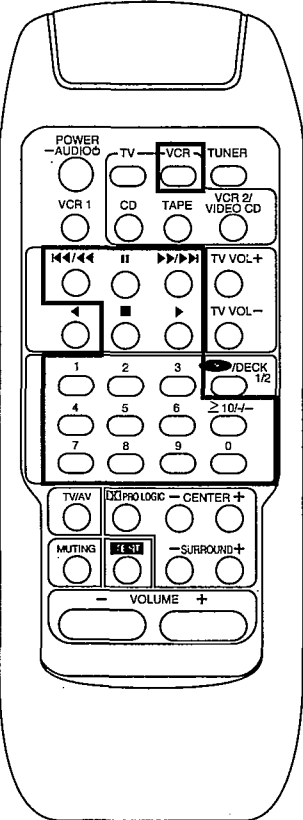
	To turn the unit ON/OFF	POWER -AUDIO⏻  (Touch only)
	To select an input source	TUNER VCR 1 CD TAPE VCR 2/ VIDEO CD Note • PHONO can not be selected with this remote control. • Selecting TAPE turns ON the tape monitor function. Pressing it again or another input select button turns the function OFF.
	To select the Dolby Pro Logic mode	PRO LOGIC Changes as follows each time the button is pressed.  → SURROUND → 3 STEREO → (OFF)
	To output a test signal	When the 3 STEREO or SURROUND mode is ON TEST  Press once more to stop the test signal.
	To adjust the output level of the center speaker	When the 3 STEREO or SURROUND mode is ON - CENTER + Note  Output level cannot be changed when the surround mode is ON and the center mode is on PHANTOM.
	To adjust the output level of the surround speakers	When the SURROUND mode is ON - SURROUND + 
	To mute the sound level	MUTING Press once more to return to the original volume. 
	To adjust the volume level	- VOLUME + 
	If your unit is equipped with the New Technics Remote Control System (see below)	
	To turn the system OFF	POWER -AUDIO⏻  Press for approx. 2 seconds.
To listen to radio broadcasts		
Specify the preset channel using the numeric button(s). (Example: Channel 9) TUNER →  →  →  (Example: Channel 9) →  →  (Example: Channel 12)		

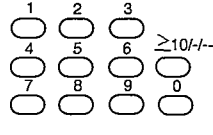
	To switch the remote control to TV operation mode		The TV can be turned on and off by pressing this button for approximately 2 seconds.
	To select the TV/VIDEO mode		The TV screen will change each time the button is pressed.
	To select the desired channel		(Example: Channel 9) (Example: Channel 12)
	To adjust the volume level		

To operate a VCR

	To switch the remote control to VCR operation mode		The VCR can be turned on and off by pressing this button for approximately 2 seconds.
	To start play		
	To select the desired channel.		(Example: Channel 9) (Example: Channel 12)
	To fast-forward or rewind the tape		In the stop mode
	To stop play temporarily		Press once again to resume play.
	To stop play		

■ OPERATION CHECKS AND MAIN COMPONENT REPLACEMENT PROCEDURE

- NOTE**
1. This section describes procedures for checking the operation of the major printed circuit boards and replacing the main components.
 2. For reassembly after operation checks or replacement, reverse the respective procedures. Special reassembly procedures are described only when required.
 3. Select items from the following index when checks or replacement are required.
 4. Illustrated screws are equivalent to actual size.
 5. Refer the parts No. on the page of "Main component Replacement Procedures", if necessary.

● Contents

•Checking Procedure for each P.C.B.

1. Checking for the FL P.C.B., tuner P.C.B. and IN/OUT terminal P.C.B.	Page. 9,10.
2. Checking for the main P.C.B.	10,11.

•Main Component Replacement Procedures

1. Replacement for the foot.	12.
2. Replacement for the power IC and regulator transistor.	12~14.
3. Replacement for the fan motor.	14.

● The following extension cable kits is necessary to check the unit's P.C.B.

•RFKZ0013(Set of 7 extension cables)

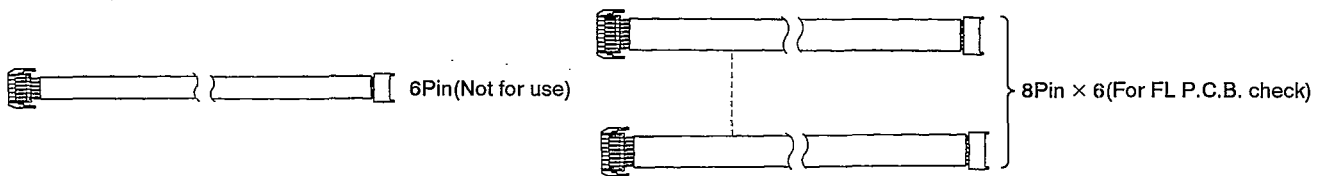

■ Checking Procedure for each P.C.B.

1. Checking for the FL P.C.B., tuner P.C.B. and IN/OUT terminal P.C.B.

Step 3
Remove the cabinet.

Step 2
b x 2

Step 1
a x 4

Tuner P.C.B. (Solder side)

IN/OUT terminal P.C.B. (Component side)

Step 5
Release the claws.

Step 6
Pull out the front panel ass'y.

Step 4
c x 3

• Check the tuner P.C.B. and IN/OUT terminal P.C.B. as shown left.

a

[SNE2129-3] (Black)

b, c

[XTBS3+8JFZ1] (Black)

NOTE

Remove the cover of extension cable.

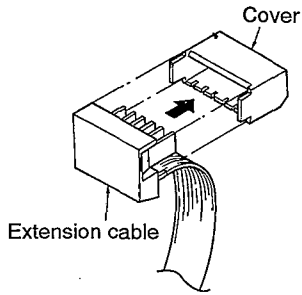

• Check the FL P.C.B. as shown below.

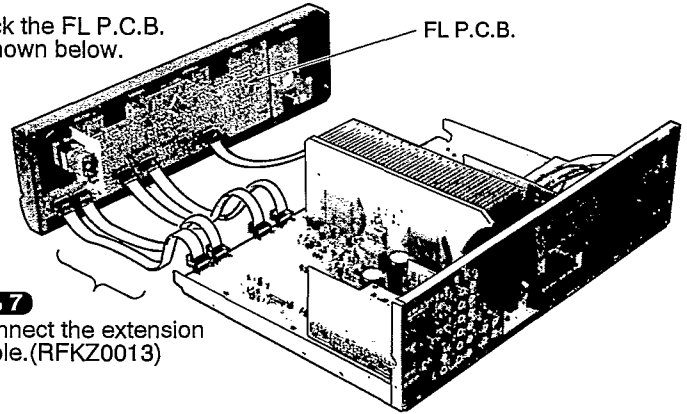

Step 7
Connect the extension cable.(RFKZ0013)

To remove each P.C.B.

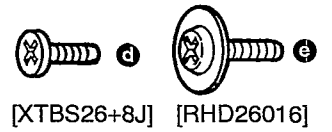
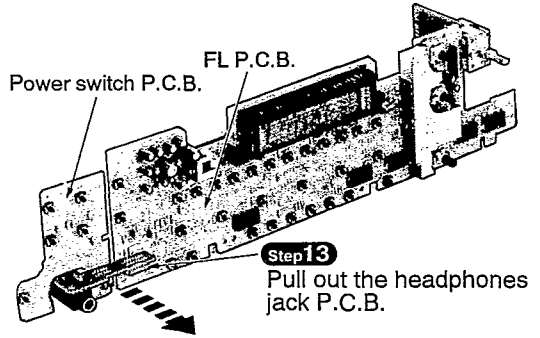
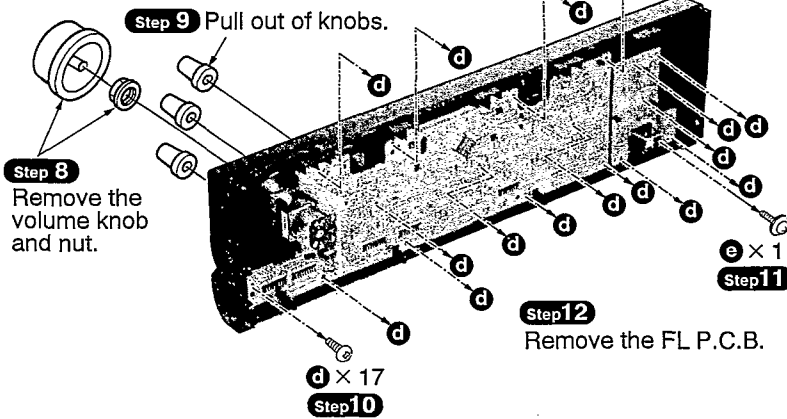

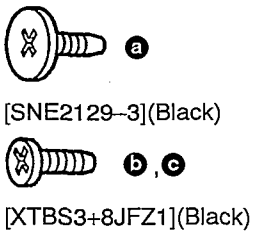
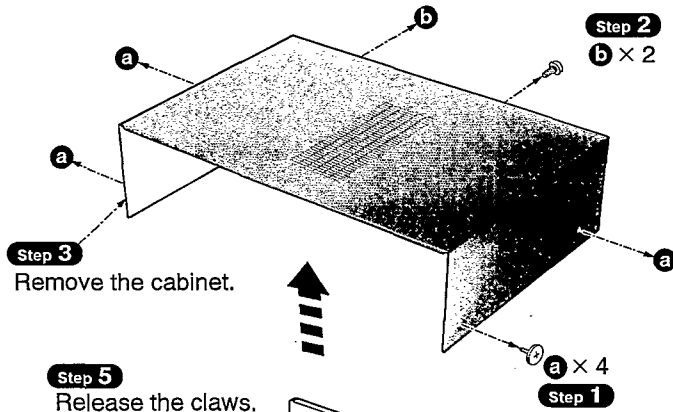

2. Checking for the main P.C.B.

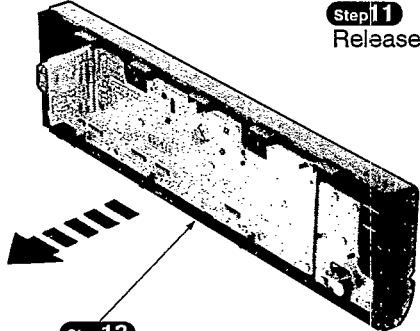
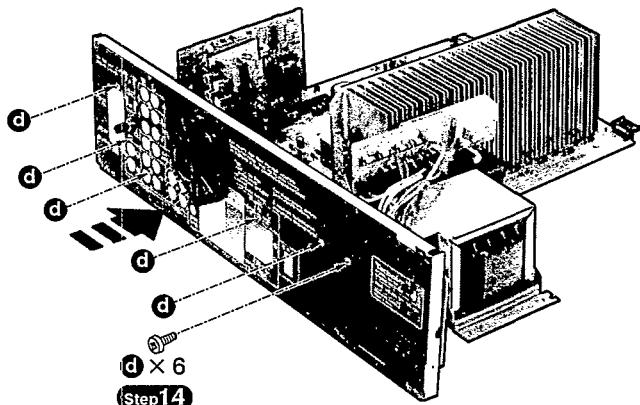
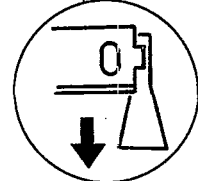
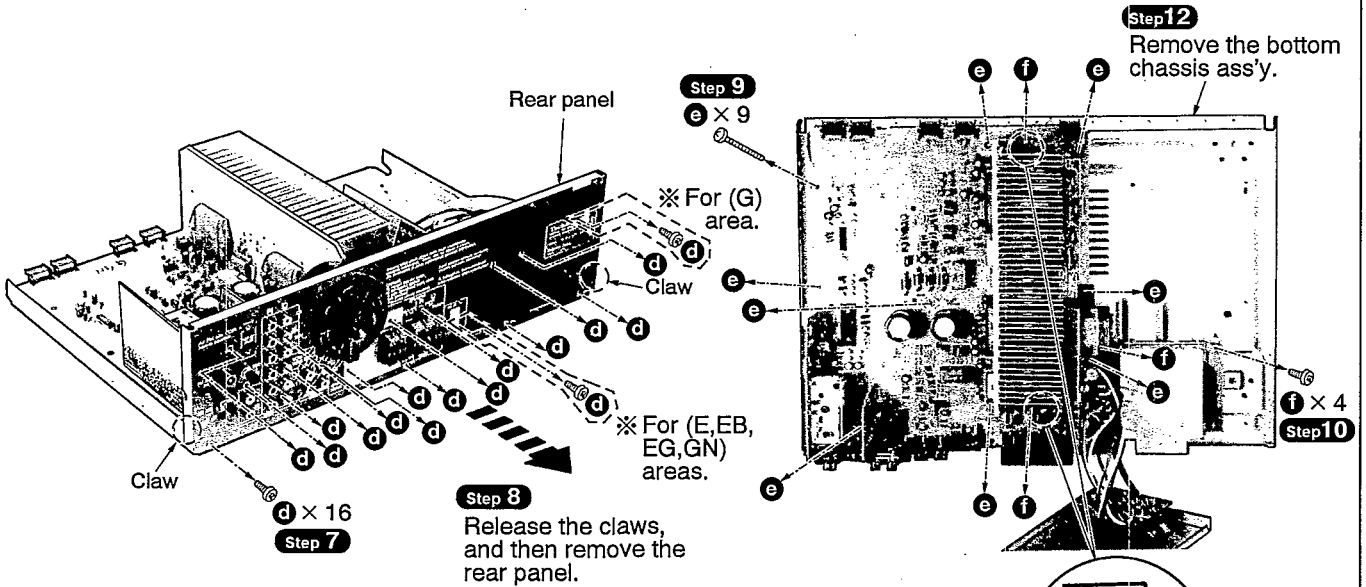

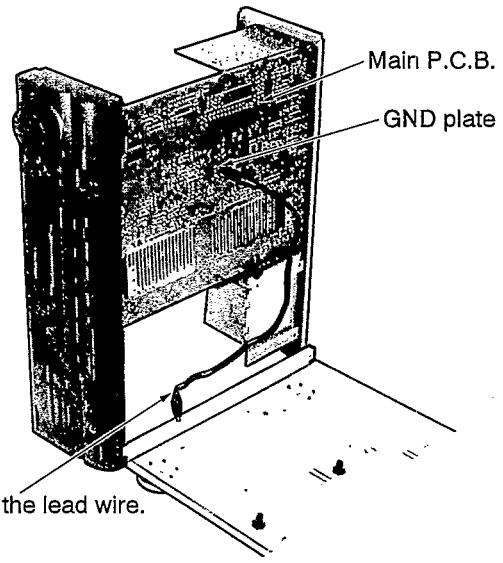

•Check the main P.C.B. as shown below.

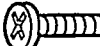
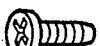

-  **d**
 [XTBS3+8JFZ1](Black)
-  **e**
 [XTB3+20JFZ](Black)
-  **f**
 [XTB3+8JFZ](Black)

Main Component Replacement Procedures

1. Replacement of the foot

• Follow the **Step 1** ~ **Step 11** in item 2 on checking procedure for each P.C.B. on pages 10 and 11.

- Step 1** Remove the 4 heat melted posts on the Bottom chassis ass'y with a pair of nippers or similar tool.
- Step 2** To replace the foot(RKA0053-A) on the Bottom chassis ass'y melt the 4 posts with a soldering iron or install it with a screw (XTB3+6J).

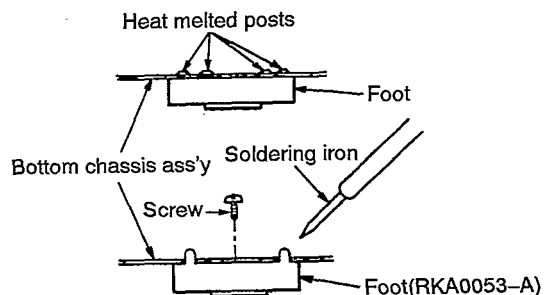
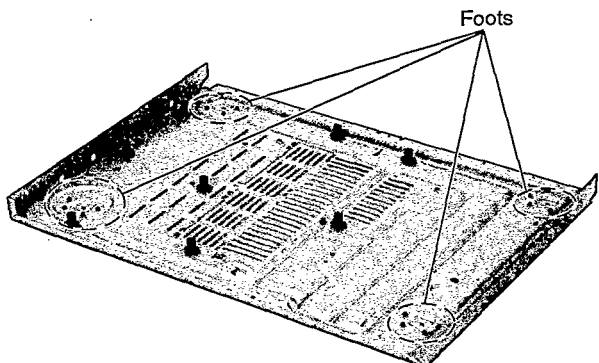

2. Replacement for the power IC and regulator transistor

• Follow the **Step 1** ~ **Step 3** in item 1 on checking procedure for each P.C.B. on page 9.

- Step 1** Cut the joints as shown below.(6 portions)

Locate the nipper to the thin portion of the joint.

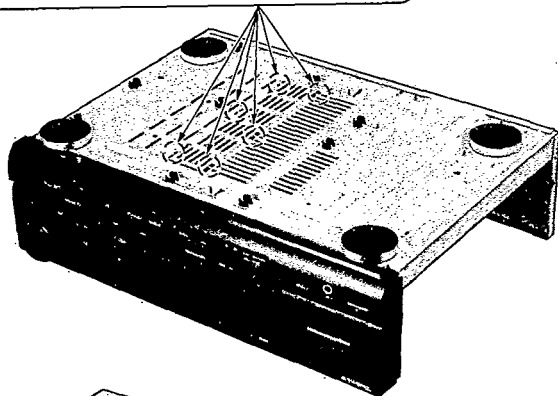
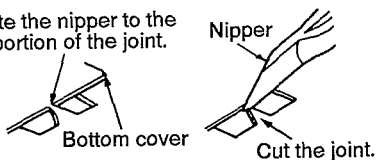

- Step 2** Fold the joints.(6 portions)

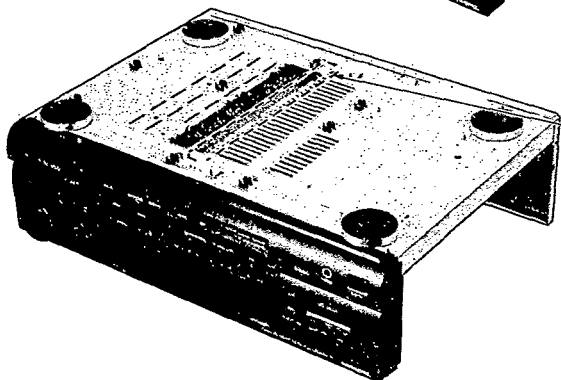
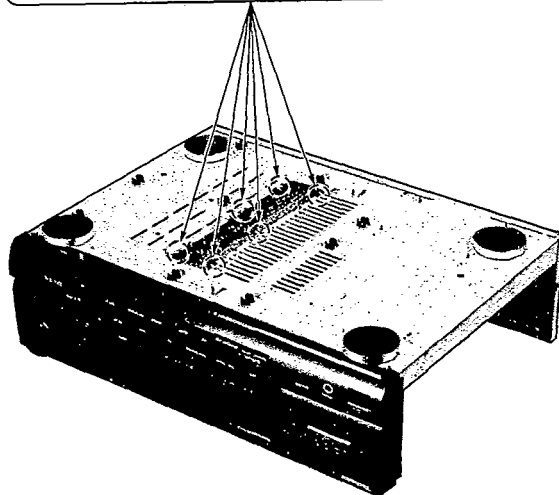
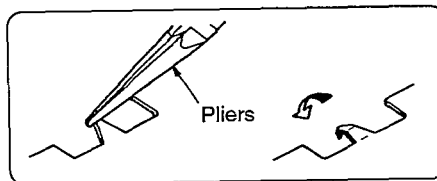

- Step 3** Unsolder the terminals of power IC and regulator transistor.

Installation of the bottom cover after replacement

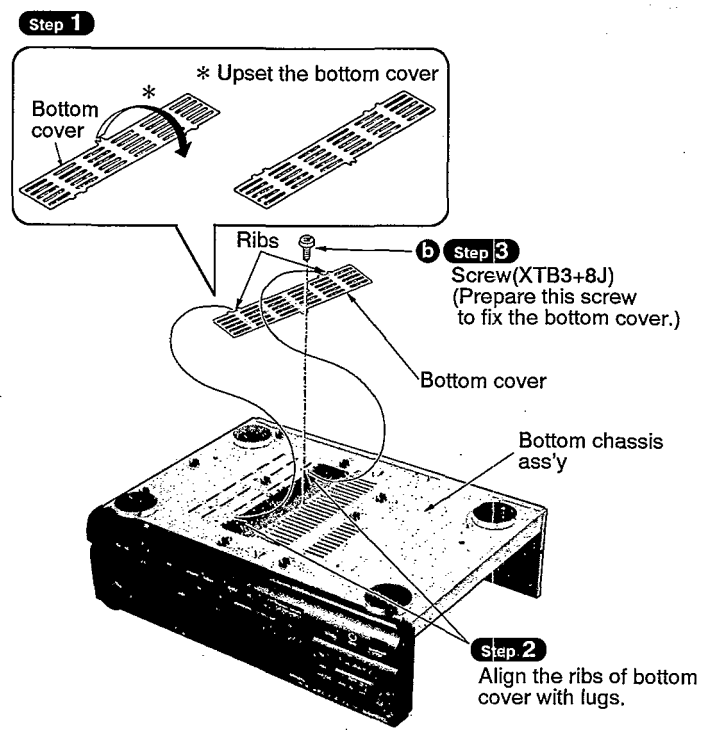
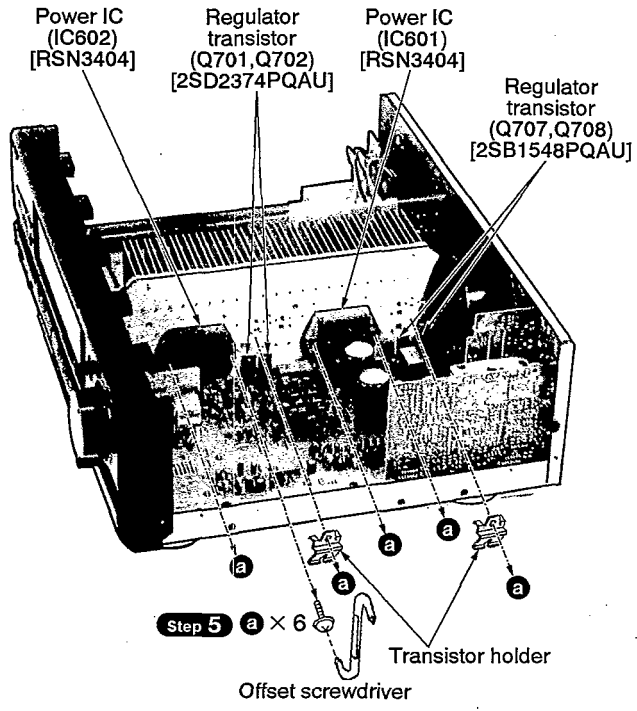

CAUTION

1. After replacing the power IC or regulator transistor, apply a sufficient quantity of compound grease (RFKX0002) between the heat sink and the power IC or regulator transistor (Radiation of power IC).
 2. Tighten enough the screws (a) after replacing the power IC and regulator transistor. Otherwise, the heat radiation works little.
 3. When installing or removing the power IC or transistor holder, be sure to use an offset screwdriver.
- A long straight screwdriver cannot be used for removal or mounting since its long grip interferes with the neighboring P.C.B. (See Fig.1)
 - A short straight screwdriver may be used for removal, but cannot be used for mounting because the limited space in the unit will not allow sufficient tightening torque. (See Fig.2)

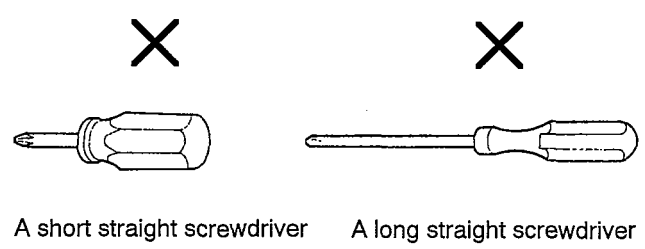
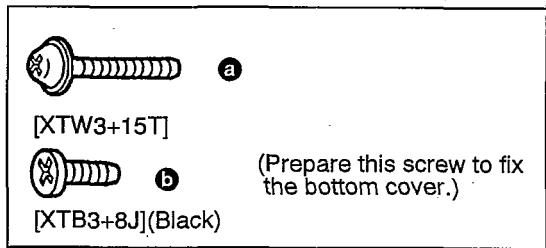

Fig.2

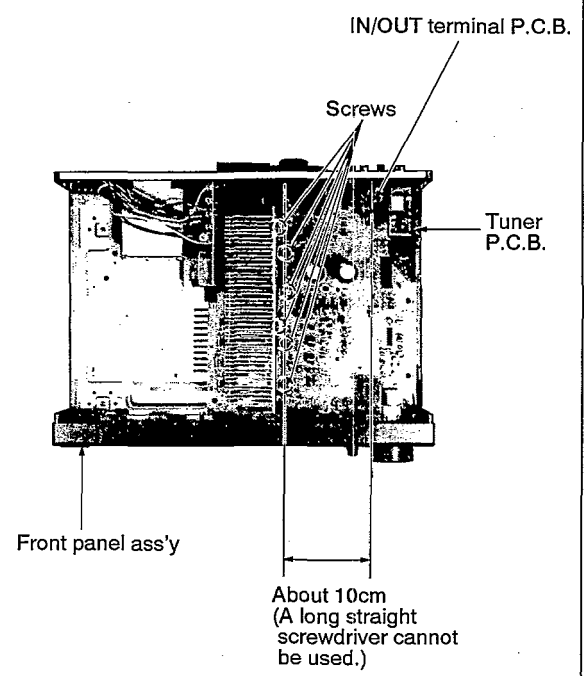
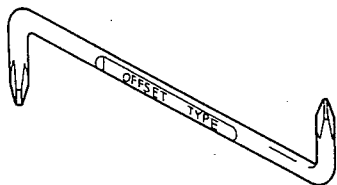

Fig.1

- Insufficient tightening will cause poor heat dissipation from the power IC and regulator transistor and, in the worst case, may lead their thermal breakdown. (See Fig.2)

—OFFSET SCREWDRIVER—

• The PROTO offset screwdriver No.34- ¼ is recommended for use in the application above.



No.		
34¼	1 & 2	4¾"

• The address of PROTO International Sales is as follows.



International Sales

International Sales Office
 Stanley-Proto Industrial Tools
 14117 Industrial Park Blvd.
 Covington, GA 30209 U.S.A.
 Fax: 706-786-4387
 Phone: 706-787-3800

Australia, New Zealand & South Pacific
 Stanley-Proto Industrial Tools
 P.O.Box 10
 400 Whitehorse Road
 Nunweding 3131
 Victoria, Australia
 Fax: 61-3-894-1173
 Phone: 61-3-878-9244

Singapore, Indonesia, Philippines, Korea, Hong Kong, Malaysia, China.
 Stanley-Proto Asia Pacific
 12 Gul Drive
 Singapore 2262
 Fax: 65-861-3206
 Phone: 65-862-0883

Thailand
 Stanley-Proto Thailand Ltd.
 1017 Moo 13 Bangnatrad Highway, Tambol Bankaew Amphur Bangplee Samutprakarn, Thailand
 Fax: 66-2-316-6071
 Phone: 66-2-316-8655

Japan
 Stanley Works Japan
 2-7-16 Hyakunin-Cho
 Shinjuku-ku
 Tokyo 160 Japan
 Fax: 81-3-3360-8456
 Phone: 81-3-3360-8458

Mexico
 Herramientas Stanley S.A. DE C.V.
 Apartado Postal 675
 72030 Puebla, Pue, Mexico
 Fax: 52-22-494-4880
 Phone: 52-22-495-300

South & Central America, Puerto Rico, The Caribbean
 Stanley Inter-America
 2101 N.W. 84th Ave.
 Miami, Florida 33122
 Fax: 305-594-4261
 Phone: 305-591-3828

Europe
 Stanley-Proto Europe
 Woodside, Sheffield
 S39PD
 England
 Fax: 44-742-739-038
 Phone: 44-742-768-888

Canada
 Stanley-Proto Canada
 1100 Corporate Drive
 Burlington, Ontario
 Canada, L7L 5R6
 Fax: 416-335-0075
 Phone: 416-335-0075

Middle East, Mediterranean & Africa
 Stanley-MEMA
 Cory House The Ring
 Bracknell Berkshire
 RG 12 1A2
 England
 Fax: 44-344-485-526
 Phone: 44-344-51813

3. Replacement for the fan motor

• Follow the **Step 1** ~ **Step 8** in item 2 on checking procedure for each P.C.B. on pages 10 and 11.

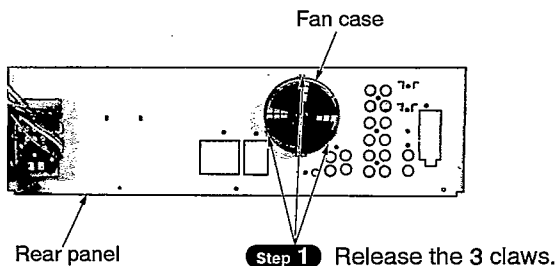

Step 2
 Put a screwdriver at the root of the fan and remove it.

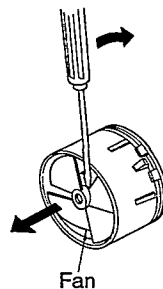

Step 3
 Remove the fan cap.

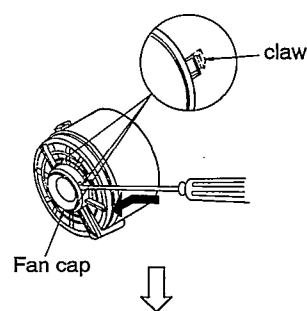

NOTE

When replacing the fan motor, align the boss of the fan case with the hole of the fan motor.

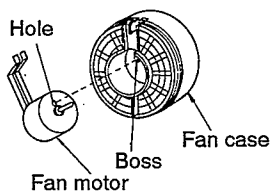

Step 5
 Remove the fan motor.

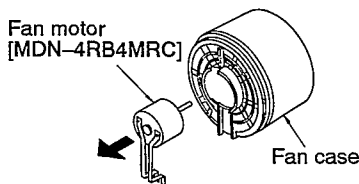

Step 4
 Remove the fan terminal cap.

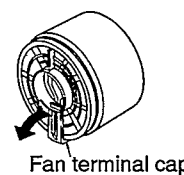

FAN MOTOR TROUBLESHOOTING

The Model SA-GX390 employ fan motor error sensing electronics.

If the cooling fan is not operation and "OVER LOAD" is displayed on the FL display, check the fan motor and its driving circuit.

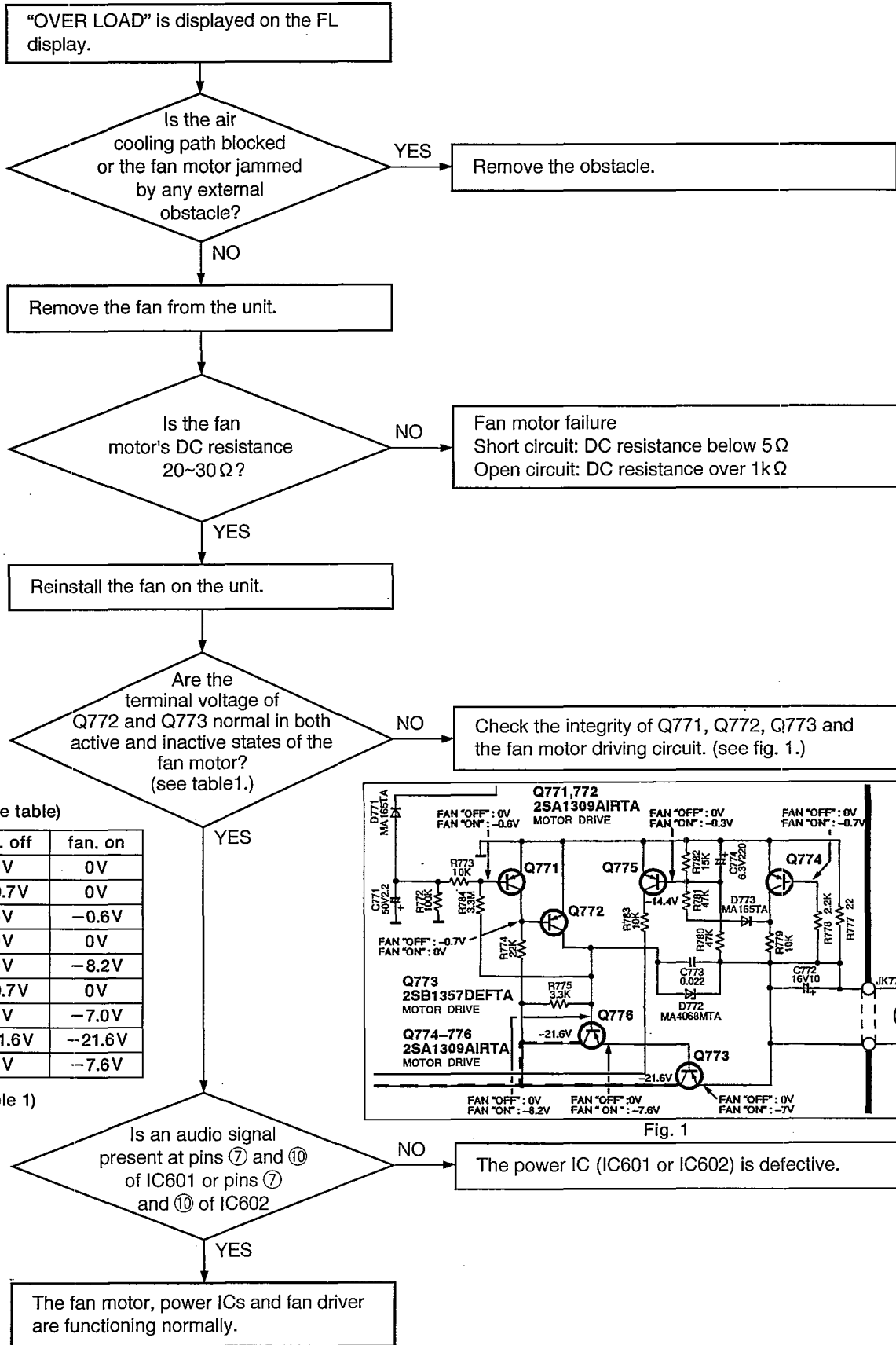

(Voltage table)

		fan. off	fan. on
Q771	E	0V	0V
	C	-0.7V	0V
	B	0V	-0.6V
Q772	E	0V	0V
	C	0V	-8.2V
	B	-0.7V	0V
Q773	E	0V	-7.0V
	C	-21.6V	-21.6V
	B	0V	-7.6V

(Table 1)

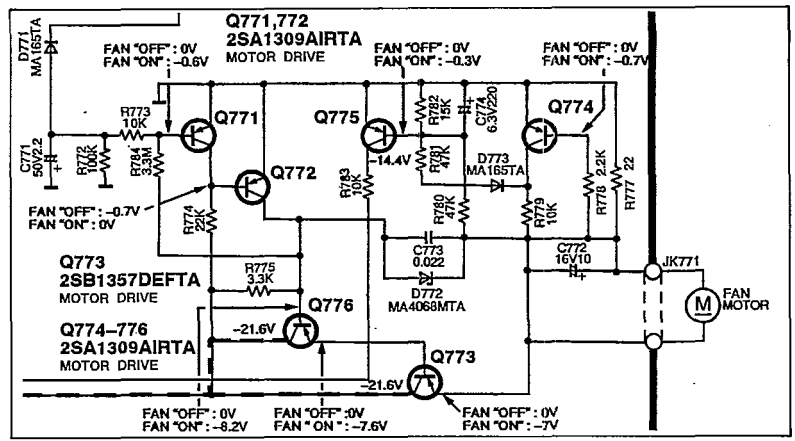

Fig. 1

■ TROUBLESHOOTING

This unit has test points on each circuit board block for use in troubleshooting.

CONNECTION

Connect either a CD player, tape deck or AF oscillator to the input terminals of the unit.

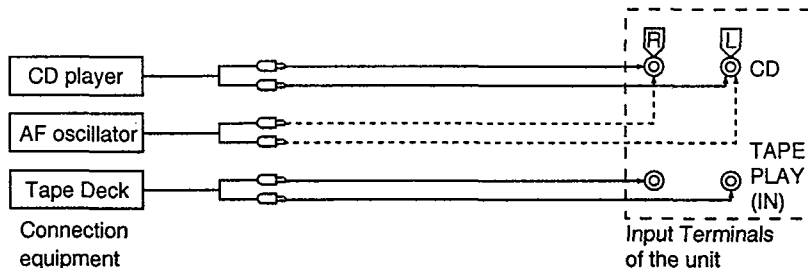

REQUIRED ITEMS

- ① Testing with a CD player ————— Test deck (SZZP1054C/first program, 1kHz, 0dB)
- ② Testing with a tape deck ————— Test tape (QZZCLA/315Hz, 0dB)
- ③ Testing with a AF oscillator ————— Set the output at 500Hz, 200mV
- ④ Oscilloscope (min. 10MHz) To measure the output waveform at the test points.

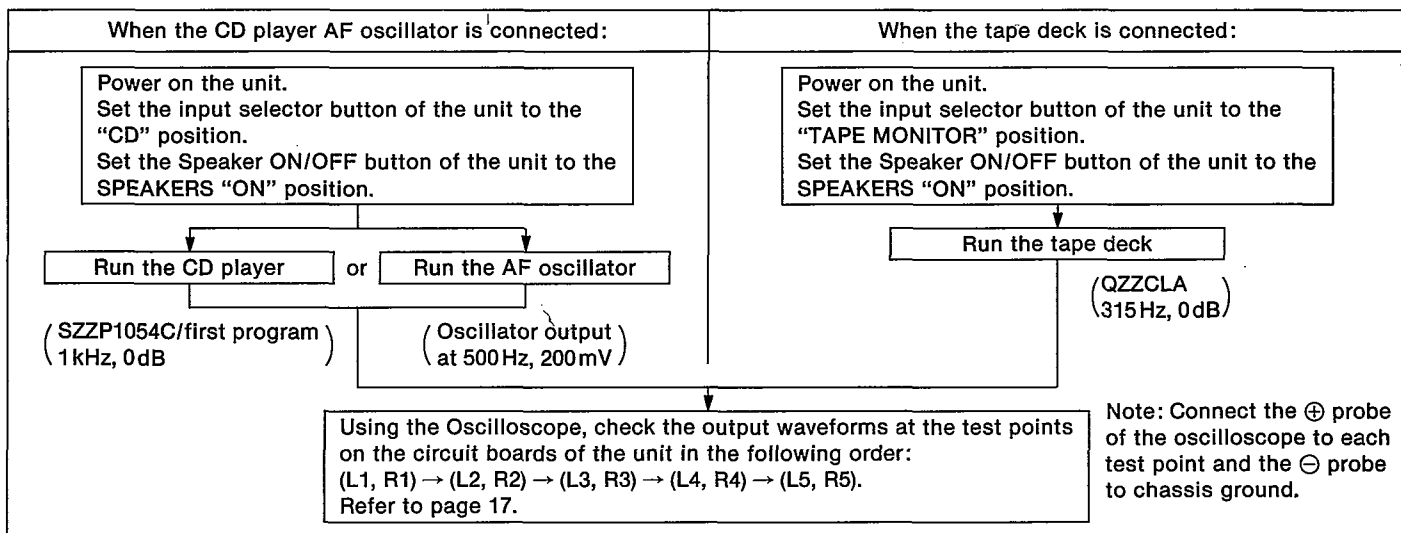

TEST PROCEDURE FOR AMPLIFIER CIRCUIT

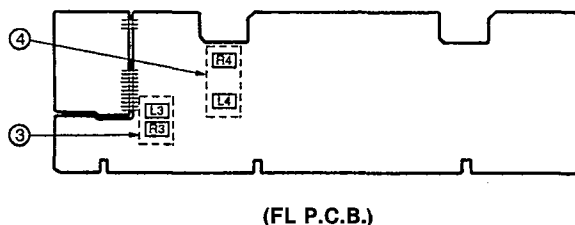
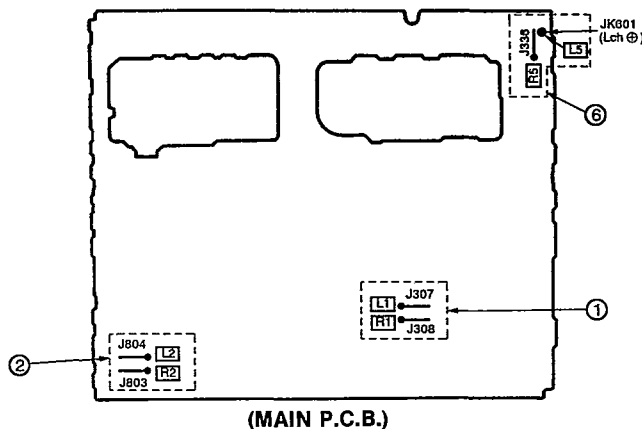

TEST POINTS POSITIONS OF AMPLIFIER CIRCUIT

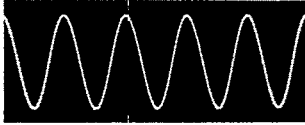

NORMAL WAVEFORMS OF AMPLIFIER CIRCUIT AND LIKELY FAULY BLOCKS

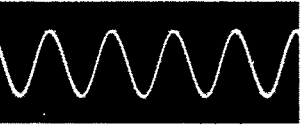
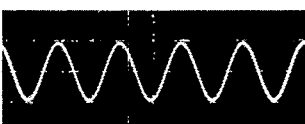
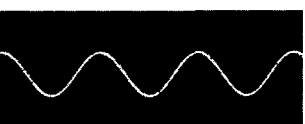
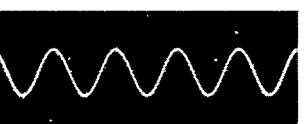
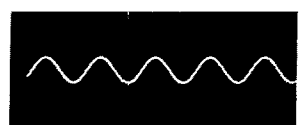
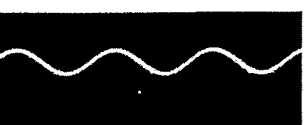
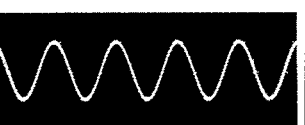
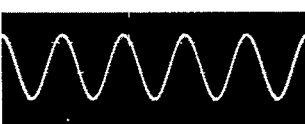
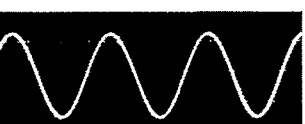
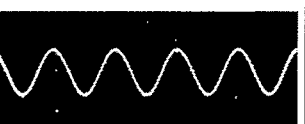
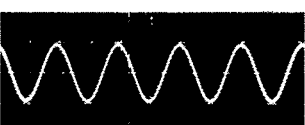
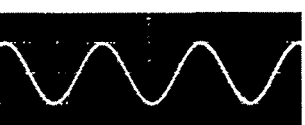
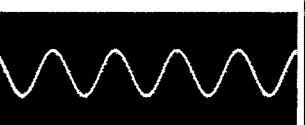
No.	TP	CD player	Tape deck	AF oscillator	Likely faulty block if the normal waveform shown at left is not present.
①	L1/R1	 0.5msec 2V	 1msec 1V	 1msec 500mV	Input selector block IC402 & area
②	L2/R2	 0.5msec 200mV	 1msec 500mV	 1msec 500mV	Dolby pro logic block IC1001 and IC1002 & area
③	L3/R3	 0.5msec 50mV	 1msec 100mV	 1msec 50mV	Master volume block VR501 & area
④	L4/R4	 0.5msec 500mV	 1msec 500mV	 1msec 1V	Tone control block IC511 & area
⑤	L5/R5	 0.5msec 5V	 1msec 500mV*	 1msec 1V*	Main amplifier block IC601 & area

Measurement conditions. Volume control (VR501), Treble control (VR512) and Bass control (VR511) positions:
* Volume control position (VR501) for these test

CHECKING PROCEDURE FOR SURROUND CIRCUIT

Outputting surround signals normally requires that opposite phase signals be applied to both the left and right channels. However, this unit incorporates a service mode, allowing the surround circuit to be tested using in-phase signals.

When the CD player or AF oscillator is connected:	When the tape deck is connected:
<div style="border: 1px solid black; padding: 5px; margin-bottom: 5px;">Power on the unit. Set the input selector button of the unit to the "CD" position.</div> <div style="text-align: center;">↓</div> <div style="border: 1px solid black; padding: 5px; margin-bottom: 5px;">While pressing both the "+" and "-" of the surround level adjustment button "SURROUND", press the "Power" button.</div> <div style="text-align: center;">↓</div> <div style="border: 1px solid black; padding: 5px; margin-bottom: 5px;">The letters 『SURR』 flash on the FL display.</div> <div style="text-align: center;">↓</div> <div style="text-align: center;">Ⓐ</div>	<div style="border: 1px solid black; padding: 5px; margin-bottom: 5px;">Power on the unit. Set the input selector button of the unit to the "TAPE MONITOR" position.</div> <div style="text-align: center;">↓</div> <div style="border: 1px solid black; padding: 5px; margin-bottom: 5px;">While pressing both the "+" and "-" of the surround level adjustment button "SURROUND" press the "POWER" button.</div> <div style="text-align: center;">↓</div> <div style="border: 1px solid black; padding: 5px; margin-bottom: 5px;">The letters 『SURR』 flash on the FL display.</div> <div style="text-align: center;">↓</div> <div style="text-align: center;">Ⓑ</div>

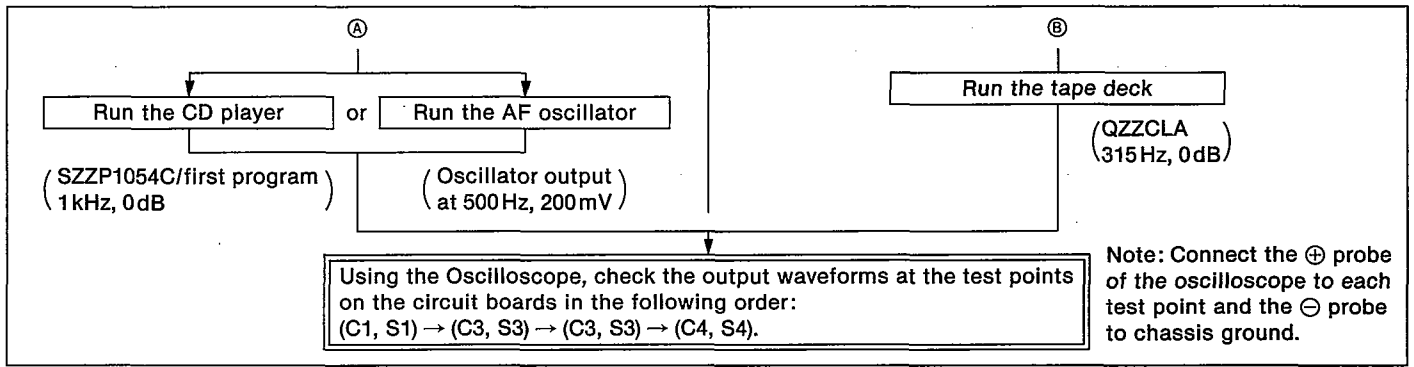

• To Exit the service mode, power off the unit.

TEST POINTS POSITIONS OF SOURROUND CIRCUIT

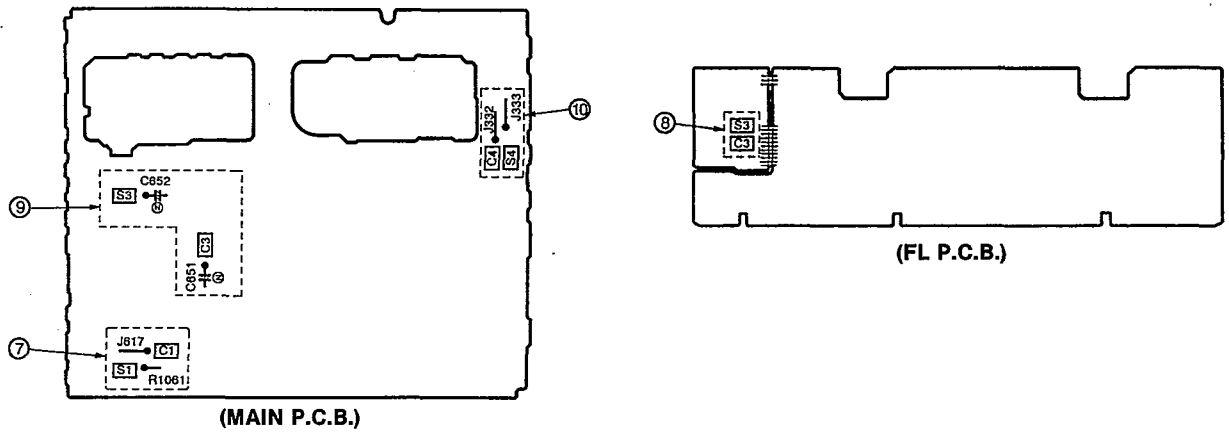

NORMAL WAVEFORMS OF SURROUND CIRCUIT AND LIKELY FAULTY BLOCKS

No.	TP	CD player	Tape deck	AF oscillator	Likely faulty block if the normal waveform shown at left is not present.
⑦	C1				Dolby pro logic block IC1001 and IC1002 & area
	S1				
⑧	C3				Master volume block VR501 & area
	S3				
⑨	C3				Tone control block & power limiter block IC551
	S3				

No.	TP	CD player	Tape deck	AF oscillator	Likely faulty block if the normal waveform shown at left is not present.
⑩	C4				Main amplifier block IC602 & area
	S4				
		0.5msec 100mV*	1msec 10V	1msec 20V	

Measurement conditions. Volume control (VR501), Treble control (VR512) and Bass control (VR511) positions: ○
 * Volume control (VR501) position for these test : ○

CIRCUIT BLOCKS

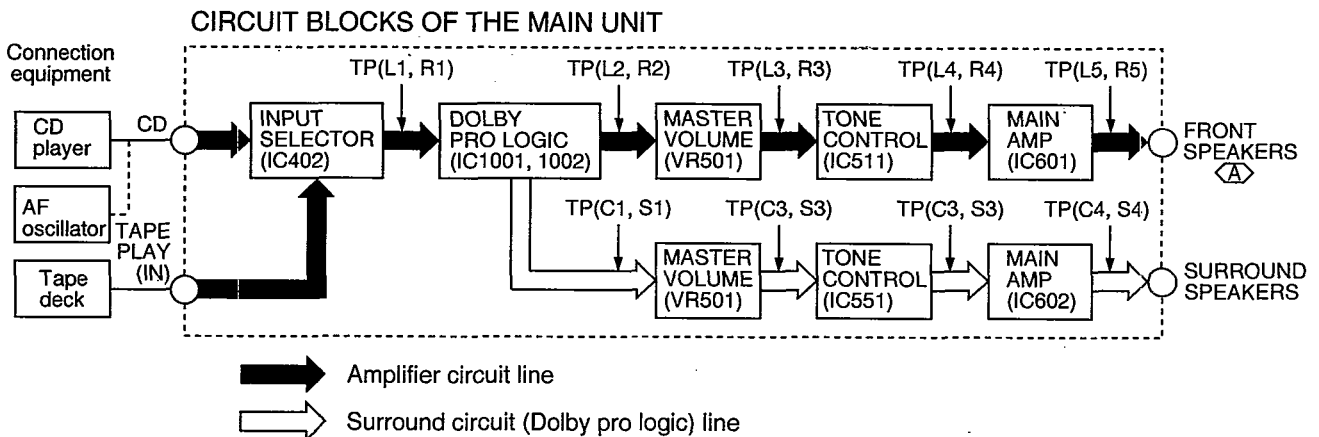

OVERLOAD DETECTION FUNCTION

The HIC protection circuit functions if any cord at a speaker terminal is short-circuited or if the unit overheats because of improper operation. At the same time, 『OVERLOAD』 scrolls across the FL display. In this state, all keys remain inoperative; if any key is pressed, 『SWITCH OFF POWER』 scrolls across the FL display. If an overload occurs, immediately power off the unit and check the speaker connections, venting holes and cooling fans. After fixing any faults, power on the unit again and check for proper operation. If no defects are found, or if the unit remains overloaded after it is power on again, check the circuit for faults.